



more **power**
to *the cube*



TAIS Cube



TAIS CUBE DESIGNED IN GRP THERMOSETTING

FOR TOUGH ENCLOSURE APPLICATIONS WHERE SPACE, INGRESS PROTECTION, QUICK INSTALLATION AND LONG SERVICE LIFE IS IMPORTANT. AVAILABLE WITH BLIND OR TRANSPARENT DOOR.

TAIS CUBE NEWLY DEVELOPED BY LEWDEN-PALAZZOLI USING THE LATEST MANUFACTURING AND MATERIALS TECHNOLOGIES FOR SUSTAINABLE PROCESSES, PRODUCTS AND RECYCLING.

100%
ECO
SAFE

Tais Cube flexible and cost effective solutions for industry, commerce, rail, power distribution, switching automation, control and monitoring.

More space with Tais Cube.

- At the same nominal sizes, TAIS Cube has +30% volume and +20% wider internal visibility
- The transparent door is the widest available on the market
- The blank sides can be customized according to any specific need
- Hinges are unbreakable and far from the edges for added protection
- Doors are reversible and are fastened with stainless steel hinges
- The opening of the doors is more than 180° and does facilitate operation and installation
- The frame does allow the wiring both inside and outside the distribution board
- Protection degree is IP66
- TAIS Cube does not burn or smoke, it is not toxic, it is halogen free
- Resistant to chemical and atmospheric agents
- Available in different colours, safety glass, etc
- Available with back plate and internal security door

Conformity to standards	EN 62208
Material	Halogen free thermosetting - GRP (back box, blind door, inner door, back plate) Steel (supports for installation, back plate) Methacrylate (transparent door) Stainless steel (screws and hinges) Technopolymer (internal components)
Colour	RAL 7035 Grey
Protection degree	IP66
Impact resistance	IK10
Glow wire test of the blind board	960°C
Self-extinguish grade	V0
Insulation class	II M
Operating temperature	-30°C ÷ + 70°C
Frequency	0 ÷ 1000Hz
Rated insulation voltage AC	1000Vac
Rated insulation voltage DC	1500Vac
Rated impulse seal voltage	8kV
Maximum short-circuit current Icc	35kA

RESISTANCE AGAINST CHEMICAL AND ATMOSPHERIC AGENTS

DETERGENTS	WINE	ACIDS		BASES		SOLVENTS				SALINE SOLUTION	UV RAYS
		DILUTED	CONCENTRATED	DILUTED	CONCENTRATED	ALCOHOL	ACETONE	ORGANIC HALIDES	BENEZENE		
✓	✓	✓	Limited reistance	✓	✓	✓	✓	✓	✓	✓	✓

FEATURES

- Resistant to weather conditions



- Impact resistance IK10



- Resistant to powerful water jets



- It does not burn, it does not smoke, it is not toxic and it is halogen free



- 100% made in Italy from renewable energy



DISTRIBUTION BOARD WITH BLIND DOOR

size 2 - code 550002



STEEL BACK PLATE
code 550602

INNER DOOR
code 550502

DISTRIBUTION BOARD WITH TRANSPARENT DOOR

size 2 code 550032

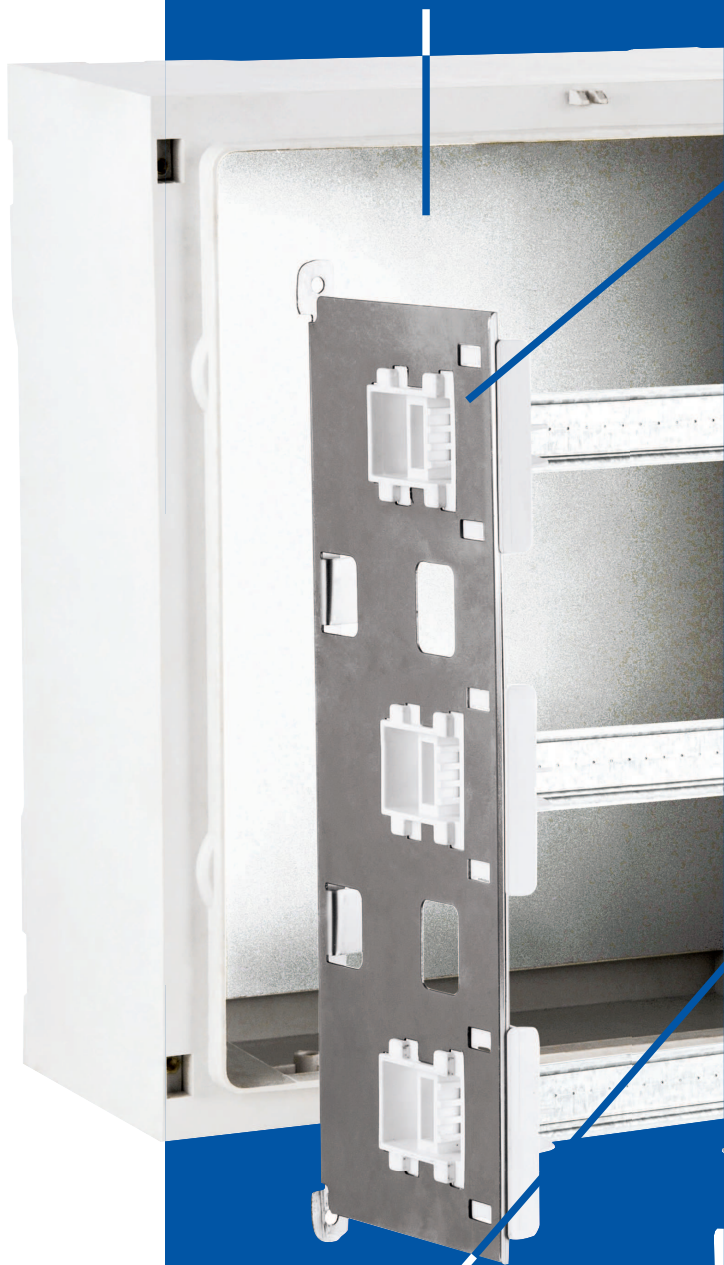

BLIND PANEL
code 550542

+30%

EXTRA SPACE AND VOLUME

FRAMES

code 550562

DIN RAIL (EN 50022)

code 550582



Unbreakable stainless steel hinges far from the edges



Trunkings predispositions in horizontal and vertical for “state-of-art” wiring

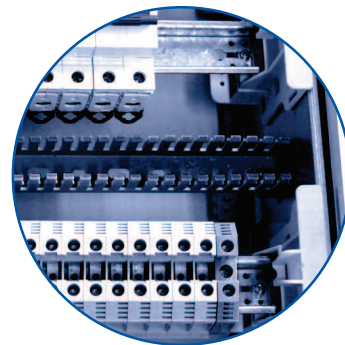







WINDOWED PANEL



code 550522

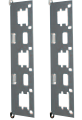

SIZE	1	2	3	4	5	6	7
NO. VERTICAL MODULES	-	3	3	4	4	5	5
NO. DIN MODULES	-	36 (3X12)	54 (3X18)	72 (4X18)	96 (4X24)	140 (5X28)	200 (5X40)
EXTERNAL DIMENSIONS	L: 260 H: 305 P: 160	L: 340 H: 430 P: 180	L: 450 H: 505 P: 220	L: 450 H: 655 P: 220	L: 560 H: 655 P: 260	L: 630 H: 810 P: 300	L: 850 H: 1060 P: 350
INTERNAL DIMENSIONS	L: 200 H: 250 P: 100	L: 280 H: 375 P: 120	L: 390 H: 450 P: 160	L: 390 H: 600 P: 160	L: 500 H: 600 P: 200	L: 570 H: 750 P: 235	L: 790 H: 1000 P: 290
DISTRIBUTION BOARD WITH BLIND DOOR	550001	550002	550003	550004	550005	550006	550007
DISTRIBUTION BOARD WITH TRANSPARENT DOOR	550031	550032	550033	550034	550035	550036	550037

AUTOMATION		STEEL BACK PLATE	550601	550602	550603	550604	550605	550606	550607
		INSULATING BACK PLATE IN THERMOSETTING (GPR)	550621	550622	550623	550624	550625	550626	/
		INNER DOOR	/	550502	550503	550504	550505	550506	550507

DISTRIBUTION		FRAMES	/	550562	550563	550564	550565	550566	550567
		WINDOWED PANEL	/	550522	550523		550525	550526	550527
		BLIND PANEL	/	550542	550543		550545	550546	550547
		DOUBLE BLIND PANEL	/	550552	550553		550555	550556	550557
		DIN RAIL	/	550582	550583		550585	550586	550587

COMMON ACCESSORIES		GALVANIZED	550640					
	SET OF 4 BRACKETS	STAINLESS STEEL	550641					
		SECURITY LOCK	550680					

DIMENSIONS

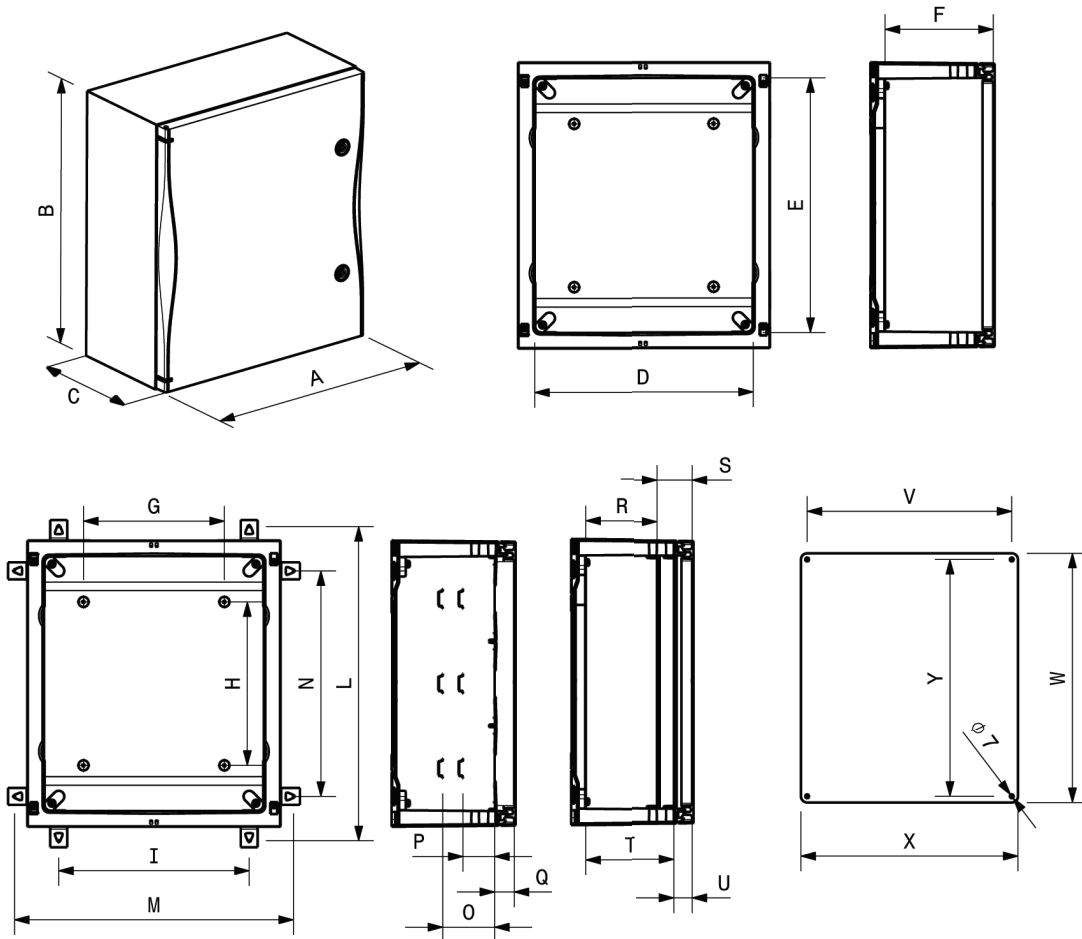

Size	A	B	C	D	E	F	G	H	I	L	M	N
1	258	304	160	200	250	131	60	87	148	355	305	198
2	340	430	180	282	376	151	142	214	230	481	386	324
3	449	506	220	390	451	191	250	290	338	556	495	399
4		656			601			439		706		
5	558	807	260	496	751	230	358	590	446	856	603	549
6	631	807	300	570	751	269	430	590	518	856	675	699
7	848	1058	350	786	1001	319	646	842	734	1106	891	949

Size	O	P	Q	R	S	T	U	V	W	X	Y
1	-	-	-	-	-	-	-	172	240	180	222
2	92	56	34	89	62	119	32	254	370	260	348
3				129		159		362	445	370	423
4				168		198		470	595	475	573
5				207		237		542	745	550	723
6				257		287		758	995	766	973
7											



THE RANGE



Distribution board in thermosetting (GRP) with blind door IP66 – Class 2

Size	External dimensions (mm)	Internal dimensions (mm)	Power dissipation (W)	Code	Pack q.ty
1	260X305X160	200X250X100	53	550001	1
2	340X430X180	280X375X120	90	550002	
3	450X505X220	390X450X160	138	550003	
4	450X655X220	390X600X160	174	550004	
5	560X655X260	500X600X200	217	550005	
6	630X810X300	570X750X235	302	550006	
7	850X1060X350	790X1000X290	506	550007	

Includes: key with triangular insert, screwcaps for class 2



Distribution board in thermosetting (GRP) with transparent door IP66 – Class 2

Size	External dimensions (mm)	No. DIN modules	Power dissipation (W)	Code	Pack q.ty
1	260X305X160	-	53	550031	1
2	340X430X180	36 (3X12)	90	550032	
3	450X505X220	54 (3X18)	138	550033	
4	450X655X220	72 (4X18)	174	550034	
5	560X655X260	96 (4X24)	217	550035	
6	630X810X300	140 (5X28)	302	550036	
7	850X1060X350	200 (5X40)	506	550037	

Includes: key with triangular insert, screwcaps for class 2



Distribution board in thermosetting (GRP) with blind door and steel back plate IP66 – Class 2

Size	External dimensions (mm)	Internal dimensions (mm)	Power dissipation (W)	Code	Pack q.ty
1	260X305X160	200X250X100	53	P550011	1
2	340X430X180	280X375X120	90	P550012	
3	450X505X220	390X450X160	138	P550013	
4	450X655X220	390X600X160	174	P550014	
5	560X655X260	500X600X200	217	P550015	
6	630X810X300	570X750X235	302	P550016	
7	850X1060X350	790X1000X290	506	P550017	

Includes: key with triangular insert, screwcaps for class 2

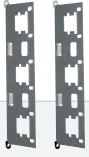

Steel functional frames for the installation of front panels and DIN rails (EN 50022)

Size	No. of panels	Code	Pack q.ty
2	3	550562	6
3	3	550563	6
4	4	550564	4
5	4	550565	2
6	5	550566	2
7	5	550567	1

Includes: fixing screws

Characteristics: allows the installation of modular front panels and DIN rails (EN 50022) at different depths



Front windowed panels with DIN rails (EN 50022) for modular devices

Size	Height (mm)	No. DIN modules	Code	Pack q.ty
2	125	12	550522	6
3 - 4	150	18	550523	6
5	150	24	550525	4
6	150	28	550526	4
7	200	40	550527	1

Includes: fixing screws

Characteristics: allows the installation of modular front panels and DIN rails (EN 50022) at different depths



Front blind panels at single height

Size	Height (mm)	Code	Pack q.ty
2	125	550542	6
3 - 4	150	550543	6
5	150	550545	4
6	150	550546	4
7	200	550547	1

Includes: cover modules

Characteristics: click-on fixing on the supports



Front blind panels at double height

Size	Height (mm)	Code	Pack q.ty
2	250	550552	4
3 - 4	300	550553	4
5	300	550555	1
6	300	550556	1
7	400	550557	1

Includes: cover modules

Characteristics: click-on fixing on the supports

THE RANGE



Reinforced galvanized DIN rails (EN 50022) for functional supports

Size	No. DIN modules	Code	Pack q.ty
2	12	550582	6
3 - 4	18	550583	6
5	24	550585	2
6	28	550586	2
7	40	550587	1

Includes: fixing screws



Galvanized steel back plates

Size	Dimensions (mm)	Code	Pack q.ty
1	180X240	550601	5
2	260X370	550602	5
3	370X445	550603	5
4	370X595	550604	5
5	475X595	550605	1
6	550X745	550606	1
7	765X995	550607	1

Includes: fixing screws

Characteristics: thickness of the plates 1,2 mm



Thermosetting (GRP) back plate

Size	Dimensions (mm)	Code	Pack q.ty
1	180X240	550621	5
2	260X370	550622	5
3	370X445	550623	5
4	370X595	550624	5
5	475X595	550625	1
6	550X745	550626	1

Includes: fixing screws

Characteristics: thickness of the plates 3 mm



Inner door in thermosetting (GRP)

Size	Dimensions (mm)	Code	Pack q.ty
2	280X375	550502	4
3	388X450	550503	4
4	388X600	550504	4
5	496X600	550505	1
6	568X750	550506	1
7	784X1000	550507	1

Characteristics: the inner door is reversible and can be easily opened with its handles.
Can be used as back plate.



Set of multi-purpose brackets for the wall mounting of the distribution boards

No. brackets	Material	Code	Pack q.ty
4	GALVANIZED	550640	20
4	STAINLESS STEEL	550641	5



Security lock with handle

No. keys	Material	Code	Pack q.ty
2	STAINLESS STEEL	550680	10



Cup shaped milling cutters equipped with quick special steel drill connection with tungsten carbide gear teeth specific for thermosetting (GRP) material

Type hole	Nominal diameter (mm)	Code	Pack q.ty
PG 13,5	20	538400	1
PG 16	22		
PG 21	29		
PG 29	38		
PG36	46		
M20	20,5	538410	1
M25	25,5		
M32	32,5		
M40	40,5		

TAIS *Cube*

more **power**
to *the* cube



TAIS Cube IP66
Palazzoli



Palazzoli S.p.A.

Via F. Palazzoli, 31 - 25128 Brescia - Italy
Tel. +39 030 2015.1 - Fax +39 030 2015.258
www.palazzoli.com - export@palazzoli.com



Lewden Electrical Industries Ltd

Argall Avenue – London E10 7QD – United Kingdom
Tel. +44 (0)20 8539 0237 – Fax +44 (0)20 8558 2718
www.lewden.com – sales@lewden.co.uk